



# M.T.H.

ELECTRIC TRAINS.

7020 Columbia Gateway Drive  
Columbia, MD 21046-1532

[www.mth-railking.com](http://www.mth-railking.com)

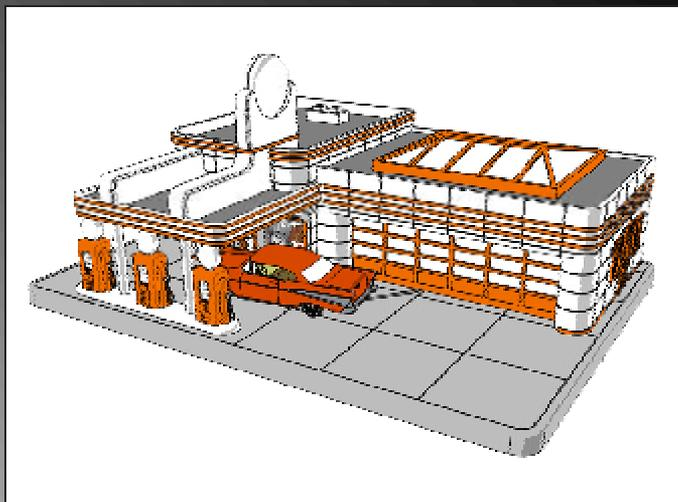

The RailKing® Operating Gas Station adds a touch of period authenticity to any O Gauge layout. Constructed from sturdy ABS plastic and painted in a familiar and authentic scheme, the gas station is sure to please anyone who likes to see action on a layout.

The gas station is pre-assembled, so setup is quick and easy. Just follow the directions and diagrams inside.

# Operating Gas Station

## WIRING INSTRUCTIONS

The RailKing® GasStationismadeupofthreecomponents:the gasstation building andbase,thecar,andtheactivationbutton. Beforeyou place the gasstationonthe layout,youmustwireittotheactivationbuttonand transformer. In ordertoconnectpowertoeachcomponent,thesix(6) enclosedwires mustbeconnectedtothewiringpostslocatedonthe undersideofthegasstationandthe activationbutton. WiresfromportsA-C controlthecar operation. Wiresfrom ports D-Econtrol the lights. Follow thediagramshownto makethecorrectconnections.

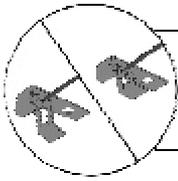

StripZ-wirecableharness insulationto reveal1/4"of barewire.

- A** ConnectRedwireto transformerACand connectBlackwireto activationbutton
- B** ConnectBlackwireto transformerground
- C** ConnectBlackwireto activationbutton
- D** ConnectRedwireto transformerAC
- E** ConnectBlackwireto transformerground

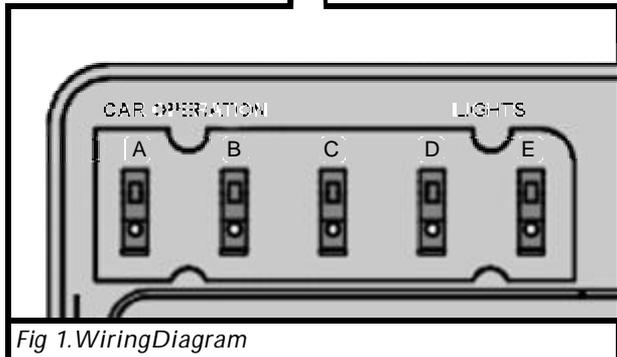
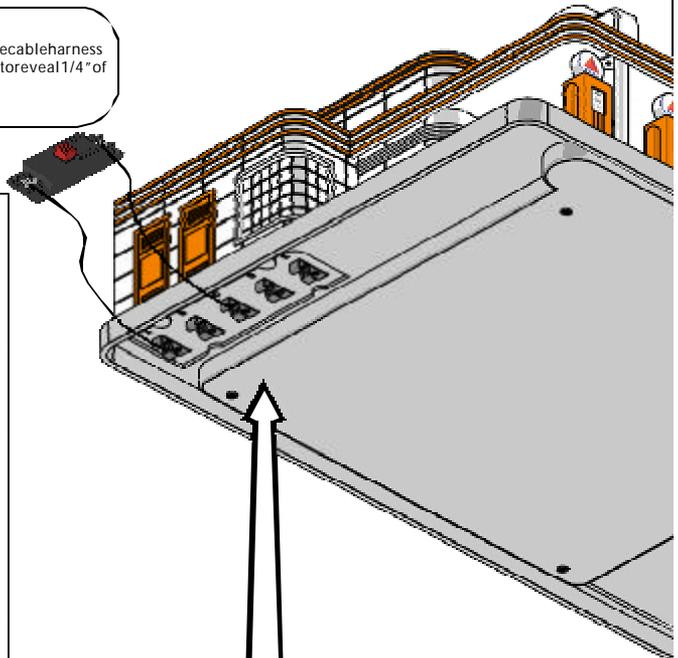

Fig 1. Wiring Diagram

**Final Touches:** : To protect part of the rooftop sign from breaking during transit, the sign is packaged separately, in a small plastic bag. To complete setup, pop the circular part of the sign into the hole designed for it on the sign base.

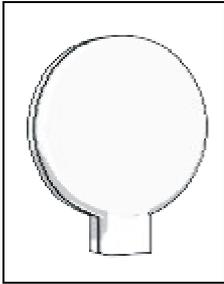

Fig2. Circular part of the rooftop sign that is packaged separately

**Operating Instructions:** Once the gas station is wired to receive a 14-20 volt minimum power supply from the transformer and the transformer is turned on, simply press the activation button to start the gas station sequence.

In order to get the car into the gas station service bay, you must press the activation button to begin the cycle. Once the small tab that will carry the car along its track has exited the gas station and come to a stop, place the car onto the tab. When you play the return sequence, the car will be taken into the garage.

In the beginning sequence, the garage door will open, and you will hear the sound of the car engine starting. The car will roll from the garage to the pumps, which will trigger the service bell to ring. Once the car has come to a stop at the gas pumps, the sound of the pump filling the car will play for approximately five seconds. After the pump sounds stop, the car will remain at the pumps until the operator pushes the activation button.

When you push the activation button a second time, the car engine will start up and the car will back into the service bay. Once the car has come to a stop, the engine sounds will shut down and the bay door will close.

You can stop the motion at any time by turning off the power or by pressing the transformer's direction button. Once the power is restored, the car will return to its starting position within the bay without sound effects.

**Replacing the Light Bulbs:** There are several easy-to-change light bulbs located in the gas station. Follow the instructions below to change them.

**Sign Light:** Pop the circular part of the sign off to access the bulb. To replace the bulb, simply pull it out and push a new one in, like Christmas tree lights (See Fig. 4).

**Pump Lights:** Pop the gas pump off the base to access the bulb. To replace the bulb, pull it out and push a new one in, like the sign light (See Fig. 4).

For the building and garage bulbs, you must first access the interior of the housing as follows:

- Remove the car from the gas station.
- Turn the building and base upside down, propping it carefully. Remove the four (4) screws from the base cover then lift the base cover off (See Fig. 3).
- Remove the ten (10) screws located on the bottom of the base. There is no need to remove the gear. Note that the two screws that hold the pump in place are longer than the others and be sure to replace them in the correct location when reassembling (See Fig. 3).
- Carefully turn the gas station back over and tilt the housing away from the base. The wiring will remain connected.
- Replace the light bulbs as described below:

**Building Lights:** Twist the bulbs counter-clockwise then pull to remove them. Push in and twist clockwise to replace the bulb (See Fig. 4).

**Garage Light:** Pull the bulb out and push the new one in to replace it (See Fig. 4).

Reassemble the gas station in the reverse order given above.

You can obtain replacement bulbs directly from the M.T.H. Parts Department (phone: 410-381-2580; e-mail: [parts@meth-railking.com](mailto:parts@meth-railking.com); mail: 7020 Columbia Gateway Drive, Columbia MD 21046-1532).

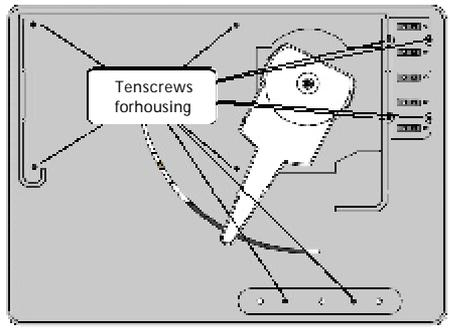
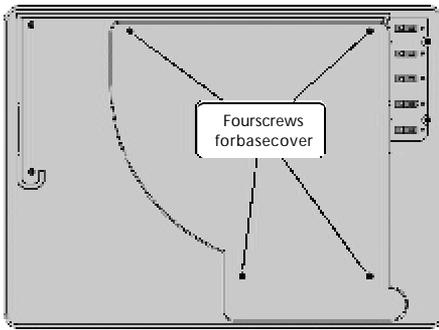

Fig 3. Removingthetwosetsoffourandtenscrewstorevealtheinsideofthebuilding

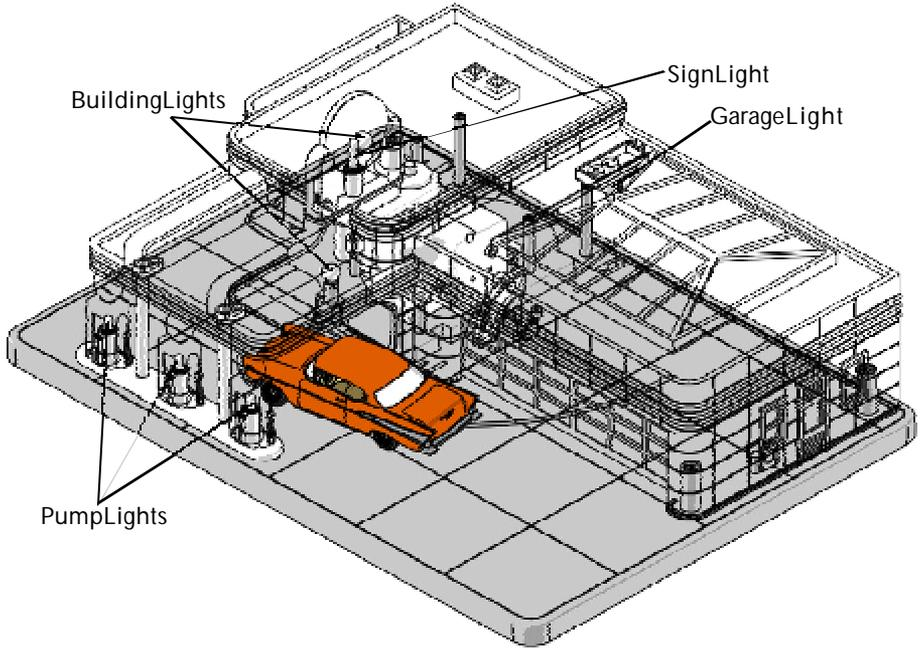

Fig4. Locationsoftheinteriorbulbsofthe GasStation

## **CAUTION: ELECTRICALLY OPERATED PRODUCT:**

Not recommended for children under 8 years of age without adult supervision. As with all electric products, precautions should be observed during handling and use to reduce the risk of electric shock.

**WARNING:** When using electrical products, basic safety precautions should be followed including the following:

- Read this manual thoroughly before using this device.
- M.T.H. recommends that all users and persons supervising use examine the unit periodically for conditions that may result in the risk of fire, electric shock, or injury to persons, such as damage to the primary cord, plug blades, housing, output jacks or other parts. In the event such conditions exist, the unit should not be used until properly repaired.
- This unit is intended for indoor use. Do not use if water is present. Serious injury or fatality may result.
- Do not operate with damaged wires or clips.
- Do not use this unit for other than its intended purpose. This unit was designed to operate with any AC or DC output toy train transformer. See the transformer's operating instructions for more operating and safety information.



## **How to Get Service Under the Terms of the Limited One-Year Warranty**

For warranty repair, do not return your product to the place of purchase. Instead, follow the instructions below to obtain warranty service, as our dealer network is not prepared to service the product under the terms of this warranty.

1. First, write, call or FAX M.T.H. Electric Trains, 7020 Columbia Gateway Drive, Columbia, MD 21046, (Tel: 410-381-2580; FAX: 410-423-0009; e-mail: [service@mth-railking.com](mailto:service@mth-railking.com)), stating when it was purchased and what seems to be the problem. You will be given a return authorization number to assure that your merchandise will be properly handled upon its receipt.
2. **CAUTION:** Make sure the product is packed in its original factory packaging including its foam and plastic wrapping material so as to prevent damage to the merchandise. The shipment must be prepaid and we recommend that it be insured. ***A cover letter including your name, address, daytime phone number, e-mail address (if available), Return Authorization number, a copy of your sales receipt and a full description of the problem must be included to facilitate the repairs. Please include the description regardless of whether you discussed the problem with one of our service technicians when contacting M.T.H. for your Return Authorization number.***
3. Please make sure you have followed the instructions carefully before returning any merchandise for service.

### **Limited One-Year Warranty**

**All M.T.H. products purchased from an Authorized M.T.H. Train Merchant are covered by this warranty.**

See our website at [www.mth-railking.com](http://www.mth-railking.com) or call 1-888-640-3700 to identify an Authorized M.T.H. Train Merchant nearby.

M.T.H. products are warranted for one year from the date of purchase against defects in material or workmanship, excluding light bulbs and traction tires. We will repair or replace (at our option) the defective part without charge for the parts or labor, if the item is returned to M.T.H. Electric Trains within one year of the original date of purchase. This warranty does not cover damages caused by improper care, handling, or use. Transportation costs incurred by the customer are not covered under this warranty.

Items sent for repair must be accompanied by a return authorization number, a description of the problem, and the **original sales receipt from an Authorized M.T.H. Train Merchant**, which gives the date of purchase. Call 410-381-2580, fax 410-423-0009, or e-mail the Service Department at [service@mth-railking.com](mailto:service@mth-railking.com) to obtain a return authorization number.

This warranty gives you specific legal rights, and you may have other rights that vary from state to state.

Service Department  
M.T.H. Electric Trains  
7020 Columbia Gateway Drive  
Columbia MD 21046-1532





# AUTHORIZED SERVICE CENTER

7020ColumbiaGatewayDr. - Columbia, MD 21046

Information: 410-381-2580 Fax: 410-381-6122

www.mth-railking.com

## PARTICIPATING RETAILER LIST OCTOBER 2001

### ALABAMA

SOUTHERLAND  
STATION

HUNTSVILLE  
256-533-4720  
railway@bellsouth.net

### ARIZONA

ARIZONATRAIN  
DEPOT

MESA  
480-833-9486  
sales@arizonatraindep  
ot.com  
www.arizonatraindepot.  
com/

### CALIFORNIA

DOLLHOUSES,  
TRAINS&MORE  
NOVATO

415-883-0388  
kbecker@cmc.net

### TIN PLATEJUNCTION

OAKLAND  
510-444-4780  
TOYTRAINS@email.m  
sn.com

### COLORADO

MIZELLTRAINSinc  
WESTMINSTER

303-429-4811  
mizelltrains@cs.com  
www.mizelltrains.com

### CONNECTICUT

SHELTON RAILROAD  
SYSTEMS  
SHELTON

203-924-8761  
adriani@clearlight.com

### NEWENGLAND

HOBBYSUPPLY  
MANCHESTER

860-646-0610  
bobbell@nehobby.com

### DELAWARE

KRRBMODEL  
TRAINSINC.

NEWARK  
302-292-2779  
info@krrb.com  
www.krrb.com

### FLORIDA

DEPOTHOBBY SHOP

LAKEWORTH  
561-585-1982  
jimmyt1982@aol.com  
www.depothobbies.co  
m

### COLONIALPHOTO&

HOBBY  
ORLANDO  
407-841-1485  
trains@colonialphotoa  
ndhobby.com

### WARRICKCUSTOM

HOBBIES  
PLANTATION  
954-370-0708  
info@warrickcustomho  
bbies.com  
www.warrickcustomho  
bbies.com

### FRANK'S TRAINS&

HOBBIES INC.  
OLDSMAR

813-855-1041  
FTH@allhobbies.com  
www.allhobbies.com

### READYTOROLL

MIAMI  
305-688-8868  
rtrtrains@aol.com  
www.readytorolltrains.c  
om

### ILLINOIS

BIKE&CHOOCHOO

CONNECTION  
SCHAUMBURG  
847-882-7728  
trainconnection@aol.c  
om

### INDIANA

Y. O. R. K. TRAINS  
MUNSTER  
219-838-9999  
yorktrains@aol.com

### SAMUELSON'STRAIN

SHOP  
VALPARAISO  
219-462-2708

### LOUISIANA

AMERICA'STRAIN  
YARD  
BATONROUGE  
225-926-5592

### MAINE

WHEELS, WINGS &  
THINGS

LUDLOW  
207-532-6277  
irc44@javanet.com

### MARYLAND

ENGINEHOUSE  
HOBBIES

GAITHERSBURG  
301-590-0816  
lucicerise@aol.com

### J&BTRAINS

HAGERSTOWN  
240-420-4930

### HOBBYTOWNU S A

FREDERICK  
301-694-7395

### PURKEY'STOY

TRAINS  
SYKESVILLE  
410-549-6061  
wiley@oldmainline.co  
m

### THETRAINROOM

HAGERSTOWN  
301-745-6681

### MASSACHUSETTS

NORTHEASTTRAINS  
PEABODY  
978-532-1615  
www.netrains.com

**MICHIGAN**  
BRASSEUR  
ELECTRICTRAINS  
INC.  
SAGINAW  
517-793-4753  
bob@traindoctor.com  
www.traindoctor.com

**MISSOURI**  
SWITCHSTAND  
SAINTLOUIS  
314-781-4458  
r41877@earthlink.com

MARKTWINHOBBY  
CENTER  
ST. CHARLES  
636-946-2816  
webmaster@hobby1.com  
www.hobby1.com

**NEWHAMPSHIRE**  
TREASUREDTOYS  
SALEM  
603-898-7224  
ttoys@treasured-  
toys.com  
www.treasured-  
toys.com

RAILROAD  
SPECIALTIES  
HUDSON  
603-882-5566  
crew@electric-  
trains.com  
www.electric-  
trains.com

**NEWJERSEY**  
TRAINS&THINGS  
TRENTON  
609-883-8790  
trainsanthings@aol.com

GRANDCENTRAL  
STATION  
KEARNY  
201-955-6200  
228gene@gateway.com

HOBBYMASTERS,  
INC  
RE DBANK  
732-842-6020  
hobbymasters@hobby-  
masters.com

HOLLYBEACHTRAIN  
DEPOT  
WILDWOOD  
609-522-2379  
larry@pro-usa.net

COASTTRAINSAND  
COLLECTIBLES  
WALL  
732-556-9005  
coasttrain@aol.com  
www.coasttrains.com

J&BTRAINS, INC.  
MAPLESHADE  
856-414-0092  
BASE1130@aol.com

HOBBYSHOP  
MATAWAN  
732-583-0505  
hobbyshopnj.com

ATLANTICRAILS  
HAMMONTON  
609-567-8490  
bobcap@pics.com  
www.atlanticrails.com

COUNTRYAND  
STUFF  
ANDOVER  
973-786-7086  
stuff@crystal.palace.net

RIDGEFIELDHOBBY  
RIDGEFIELD  
201-943-2636

COLUMBUSTRAIN  
STATION  
COLUMBUS  
609-518-1800

**NEWYORK**  
AURORARAILS &  
HOBBIES  
EASTAURORA  
716-652-5718  
rk82141@aol.com

AMERICANASTORE  
TIVOLI  
845-757-4246  
mthdepot@valstar.net

NASSAUHOBBY  
CENTER, INC.  
FREEPORT  
516-378-9594  
Charlienassau@aol.com

KROSSHARDWARE  
WESTBABYLON  
631-669-3069  
t989@aol.com

CITYDEPOT, INC.  
NEWHAMPTON  
845-374-3010  
citydepot@frontiernet.net  
www.citydepot.com

**NORTHCAROLINA**  
DRYBRIDGE  
STATION  
MOUNTAURY  
336-786-9811  
mikek@drybridgestation.com  
www.drybridgestation.com

THEFREIGHTYARD  
SMITHFIELD  
919-934-6229  
disbissette@aol.com

TRAINSLTD.  
CHARLOTTE  
704-566-9070  
modelrrs@bellsouth.net  
www.trainsltd.com

THEROUNDHOUSE  
&BACKSHOP  
CARY  
919-465-0810

**OHIO**  
DIXIEUNION  
STATION  
MASON  
513-459-0460  
rockylane@core.net  
www.dixieunionstation.com

RICK'STOYTRAINS  
TOLEDO  
419-478-0171

T&KHOBBYSHOP  
BRIDGEPORT  
740-633-6607  
salea@tkhobbies.com  
www.tkhobbies.com

TRAINS-N-THINGS  
CANTON  
330-499-1666  
trains@sssnet.com

PARMAHOBBY  
CLEVELAND  
216-741-6440  
info@parmahobby.com

GLEN'STRAINSHOP  
AKRON  
330-253-6527

E&STRAINS  
AKRON  
330-745-0785

GRANDPACIFIC  
JUNCTION  
OLMSTEADFALLS  
440-235-4777  
gpmjrr@juno.com

HUDSON TOY, TRAIN  
&HOBBY  
HUDSON  
330-653-2997  
ejpickens@aol.com

DAVISELECTRONICS  
MILFORD  
513-831-6425  
davisstrains@fuse.net  
www.davisstrains.com

SANDY'SHOBBY'S &  
COLLECTIBLES  
ELYRIA  
440-365-9999  
sandyshobb@aol.com

ERIERAILWAY  
DEPOT  
TROY  
937-440-9972  
orville@gte.net

CLEARVIEWTRAIN &  
HOBBY  
LORAIN  
440-277-4488  
klogar@erienet.net  
www.clearviewtrainand-  
hobby.com

**PENNSYLVANIA**  
FAIRCHANCE  
PHARMACY  
FAIRCHANCE  
724-564-7817  
mthdealer@aol.com  
www.hhs.net/fairchance

THESTATION  
NEWCUMBERLAND  
717-774-7096  
station@paonline.com

BUSSINGERTRAINS  
AMBLER  
215-628-2366  
choochoos@icdc.com  
www.icdc.com/~btrains

CHARLEROI  
SWEEPERCENTER  
CHARLEROI  
724-483-3397

AMERICANHOBBY  
CENTER  
ALIQUIPPA  
724-378-3930  
american@icubed.com

CRANBERRYHOBBY  
DEPOT  
CRANBERRYTWP  
724-776-3640  
JAdams6113@aol.com

ALLENTOWNTOWN  
TRAINSERVICE  
ALLENTOWN  
610-821-0740

ON THERIGHT  
TRACK  
ALTOONA  
814-942-4345

JIM'S TRAINSHOP  
HOMERCITY  
724-479-2026  
sudsy@stargate.net

YE OLDE TRAIN &  
CHRISTMASSHOPPE  
BOYERTOWN  
610-369-0755  
www.yeoldetrain.com

TOBYTYLER'S  
HOBBYCENTER  
PITTSBURGH  
412-653-5030  
tobytyler111@cs.com

BUSTLETON TRAIN  
SHOP  
PHILADELPHIA  
215-698-7266

CHESTNUT TOYBOX  
PHILADELPHIA  
215-545-0455  
chestnuttoy@earthlink.net

THE CABOOSE  
LEHIGHTON  
570-386-5352  
www.thecaboosehobbies.com  
victen@ptd.net

**SOUTH CAROLINA**  
EMERALD TRAIN &  
HOBBY  
GREENWOOD  
864-223-2247

**TENNESSEE**  
MODEL RAILROAD &  
HOBBY SHOP  
MEMPHIS  
901-384-6500  
mrhs99@earthlink.net  
www.modelrailroadandhobby.com

**TEXAS**  
HOBBY TIME  
AMARILLO  
806.352.9660  
don.l.harris.@hobbytime.com

**VIRGINIA**  
TRAIN DEPOT  
MANASSAS  
703-335-2216

NORGE STATION  
WILLIAMSBURG  
757-564-7623  
norgetrains@cs.com

NUTBUS EXPRESS  
VICTORIA  
804-696-1902  
thenutbushexp@meck.com.net

TOY TRAIN CENTER  
RICHMOND  
804-288-4475

TSG HOBBIES  
WARRENTON  
540-347-9212  
tripli@mnsinc.com  
www.mnsinc.com/tripli/sg.htm

CHESTERFIELD  
HOBBIES  
MIDLOTHIAN  
804-379-9091  
chsthobb@erols.com  
www.chesterfieldhobbies.com

DAVISHOBBY  
SUPPLIES  
PORTSMOUTH  
757-397-1983  
ralph@davishobby.com  
www.davishobby.com

LOCUST GROVE  
TRAINS  
LOCUST GROVE  
540-854-8955  
lgtrains@aol.com  
www.locustgrovetrains.com

**WEST VIRGINIA**  
PATRICK'S TRAINS  
WHEELING  
304-232-0714  
trains@patstrains.com  
www.patstrains.com

**WISCONSIN**  
SOMMERFELD'S  
TRAINS  
BUTLER  
262-783-7797  
questions@sommerfelds.com  
www.sommerfelds.com

GB TV & TRAINS  
GREENBAY  
920-496-9697  
rrtycoon@netnet.net

GRAMPA'S TRAIN  
SHOP  
RICELAKE  
715-234-2996  
grampastrainsshop@yahoo.com

THE TRAIN STORE  
WAUKESHA  
262-650-6675

HOBBY OUTLET  
FOND DULAC  
920-244-3770  
hobby\_outlet@hotmail.com

**CANADA**  
**ONTARIO**  
CREDIT VALLEY  
RAILWAY COMPANY  
STREETSVILLE  
905-826-1306  
CVRCO@globalserve.net  
www.cvrco.com

TOY TRAIN  
WORKSHOP  
CUMBERLAND  
613-833-3125  
info@toytrainworkshop.com  
www.toytrainworkshop.com

THE TRAIN ROOM  
FERGUS  
519-787-3280